



MİMARİ SİSTEM ÜRÜN KATALOĐU

ARCHITECTURAL SYSTEM PRODUCT CATALOG

www.celsametal.com.tr



CUSTOM DESIGN

PROJEYE ÖZEL
GELİŞTİRDİĞİMİZ
ÜRÜN VE
SİSTEMLERİ
TASARLIYOR VE
UYGULANMASI
KONUSUNDA
PROJELERİNİZE
ÇÖZÜMLER
SUNUYORUZ.

WE DESIGN
CUSTOM
PRODUCTS AND
SYSTEMS AND
PROVIDE SPECIAL
SOLUTIONS
FOR YOUR PROJECTS
ABOUT APPLICATION.

WD50T
WD55T / WD55
WD64T
WD70T
WD86T
FD60T
HVT67 / HVT77

CS34
CS35T
HS55T
S35T
S38T

FS50
FS65
AC22 COTTA
SKY65
SB

AD40
OP40
OP100
MF20
OP30
MS20

LOFT

WG70T
SH110
SS60
ICB40 / CB40
SCB100
ISCB140
F60

KAPI VE PENCERE SİSTEMLERİ
WINDOW AND DOOR SYSTEMS

SÜRME SİSTEMLERİ
SLIDING SYSTEMS

CEPHE VE IŞIKLIK SİSTEMLERİ
FACADE AND SKYLIGHT SYSTEMS

**OFİS BÖLME VE
İÇ MEKAN SİSTEMLERİ**
OFFICE PARTITION
INDOOR SYSTEMS

DIŞ MEKAN SİSTEMLERİ
OUTDOOR SYSTEMS

2-15

16-25

26-35

36-41

42-52

Kapı ve Pencere Sistemi
Door and Window System



WD50T

WD50T tüm pencere ve kapı tiplerinde eksiksiz çözüm sağlar.

WD50T offers a complete solution for every type of windows and doors.



WD50T Yalıtımlı Kapa & Pencere Sistemi

WD50T Thermo Door & Window System

TEKNİK ÖZELLİKLER / TECHNICAL PROPERTIES

Kasa Geniřliđi / Frame Width	50 -58 mm
Kanat Geniřliđi / Sash Width	57,4 mm
Isı Bariyeri / Thermal Break	15 mm
Profil Et Kalınlıđı / Profile Wall Thickness	1,3 - 1,5 mm
Min. Cam Kalınlıđı / Min. Glazing Thickness	4 mm
Maks. Cam Kalınlıđı / Max. Glazing Thickness	26 mm
Min. Kanat Ölçüleri / Min. Sash Dimensions	350 x 500 mm
Maks. Kanat Ölçüleri / Max. Sash Dimensions	1200 x 2300 mm
Maks. Kanat Ađırlıđı / Max. Sash Weight	100 kg

PERFORMANS DEđERİ / PERFORMANCE VALUES

EN 12152 Hava Geçirgenliđi / Air Permability	Class 4 (600 Pa)
EN 12154 Su Sızdırmazlıđı / Water Tightness	Class 9A (600 Pa)
EN 13830 Rüzgar Yüküne Dayanım / Wind Resistance	Class C3 (1200 Pa)
Min. Termal Isı Yalıtımı / Min. Thermal Insulation	Uw: 3,3 - 4,3W/(m².K)

UYGULAMA SEÇENEKLERİ / APPLICATION OPTIONS

İçe Açılır Kanat / Inward Opening Sash



Dıřa Açılır Kanat / Outward Opening Sash



Çift Açılım / Tilt and Turn Opening



Vasistas Açılım / Transom Opening



Çift Kanat Açılım / Double Sash Opening



Pivot Açılım / Pivot Opening

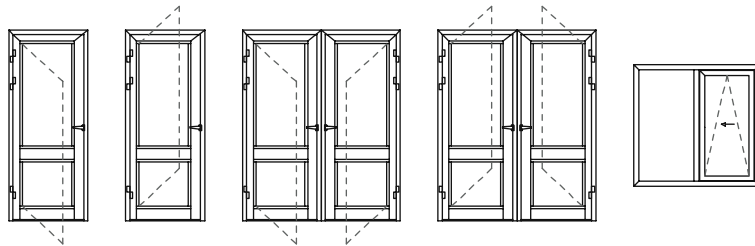
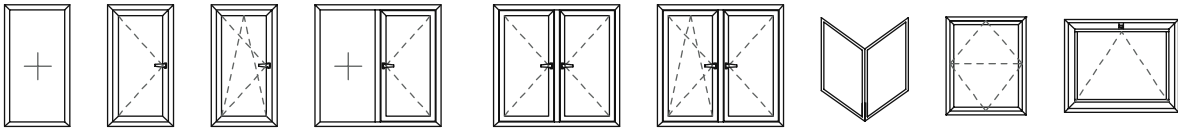

Kapı ve Pencere Sistemi Door and Window System



WD55

Isı yalıtımsız kapı ve pencere sistemi olan WD55 dar ve geniş profil alternatifleri sunar.

WD55, a non-heat insulated door and window system, offers alternative frame profiles with narrow and wide options.



WD55T

WD55T kapı ve pencere sistemi, yanmaz ısı bariyer alternatifi ile dikkat çekmektedir.

The WD55T door and window system draws attention with its non-combustible heat barrier options.



WD55 Yalıtımsız Kapı & Pencere Sistemi

WD55 Uninsulated Door & Window System

WD55T Yalıtımlı Kapı & Pencere Sistemi

WD55T Thermo Door & Window System

TEKNİK ÖZELLİKLER / TECHNICAL PROPERTIES

	WD55T YALITIMLI Insulated	WD55 YALITIMSIZ Uninsulated
Kasa Geniřliđi / Frame Width	55-64,5 mm	55-60 mm
Kanat Geniřliđi / Sash Width	63,5-73 mm	63,5 mm
Isı Bariyeri / Thermal Break	15 mm	-
Profil Et Kalınlıđı / Profile Wall Thickness	1,3-2 mm	1,3 - 2 mm
Min. Cam Kalınlıđı / Min. Glazing Thickness	4 mm	4 mm
Maks. Cam Kalınlıđı / Max. Glazing Thickness	36 mm	36 mm
Min. Kanat Ölçüleri / Min. Sash Dimensions	350 x 500 mm	350 x 500 mm
Maks. Kanat Ölçüleri / Max. Sash Dimensions	1300 x 2800 mm	1300 x 2800 mm
Maks. Kanat Ađırlıđı / Max. Sash Weight	130 kg	130 kg

PERFORMANS DEĐERİ / PERFORMANCE VALUES

EN 12152 Hava Geçirgenliđi / Air Permeability	Class 4 (600 Pa)	Class 4 (600 Pa)
EN 12154 Su Sızdırmazlıđı / Water Tightness	Class 9A (600 Pa)	Class 9A (600 Pa)
EN 13830 Rüzgar Yüküne Dayanım / Wind Resistance	Class C3 (1200 Pa)	Class C3 (1200 Pa)
Min. Termal Isı Yalıtımı / Min. Thermal Insulation	Uw: 2,7-3,7 W/(m².K)	Uw: 6,2-6,7 W/(m².K)

UYGULAMA SEÇENEKLERİ / APPLICATION OPTIONS

İçe Açılır Kanat / Inward Opening Sash



Dışa Açılır Kanat / Outward Opening Sash



Çift Açılım / Tilt and Turn Opening



Vasistas Açılım / Transom Opening



Çift Kanat Açılım / Double Sash Opening



Pivot Açılım / Pivot Opening

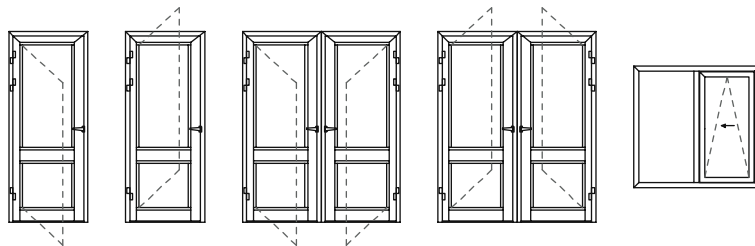
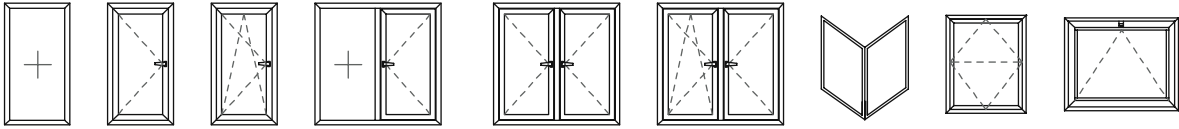

Kapı ve Pencere Sistemi

Door and Window System



WD64T

Rüzgar direnci yüksek olan WD64T Kapı ve Pencere sistemi; terleme yapmaz. Yangın yönetmeliğine uygundur. Estetik bir görünüme sahiptir.



WD64T Door and Window system with high wind resistance; does not prevents condensation. It complies with fire regulations. It has an aesthetic appearance.

WD64T Yalıtımlı Kapı & Pencere Sistemi

WD64T Thermo Door & Window System

TEKNİK ÖZELLİKLER / TECHNICAL PROPERTIES

Kasa Geniřliđi / Frame Width	64-73,5 mm
Kanat Geniřliđi / Sash Width	72,5 mm
Isı Bariyeri / Thermal Break	24 mm
Profil Et Kalınlıđı / Profile Wall Thickness	1,3-2 mm
Min. Cam Kalınlıđı / Min. Glazing Thickness	10 mm
Maks. Cam Kalınlıđı / Max. Glazing Thickness	40 mm
Min. Kanat Ölçüleri / Min. Sash Dimensions	350 x 600 mm
Maks. Kanat Ölçüleri / Max. Sash Dimensions	1300 x 2800 mm
Maks. Kanat Ađırlıđı / Max. Sash Weight	130 kg

PERFORMANS DEđERİ / PERFORMANCE VALUES

EN 12152 Hava Geçirgenliđi / Air Permability	Class 4 (600 Pa)
EN 12154 Su Sızdırmazlıđı / Water Tightness	Class 9A (600 Pa)
EN 13830 Rüzgar Yüküne Dayanım / Wind Resistance	Class C3 (1200 Pa)
Min. Termal Isı Yalıtımı / Min. Thermal Insulation	Uf: 2,0-2,7 W/(m².K)

UYGULAMA SEÇENEKLERİ / APPLICATION OPTIONS

İçe Açılır Kanat / Inward Opening Sash



Dışa Açılır Kanat / Outward Opening Sash



Çift Açılım / Tilt and Turn Opening



Vasistas Açılım / Transom Opening



Çift Kanat Açılım / Double Sash Opening



Pivot Açılım / Pivot Opening

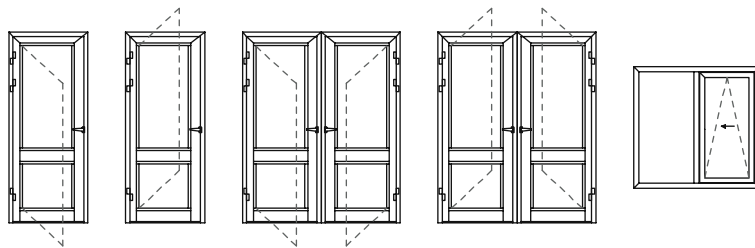
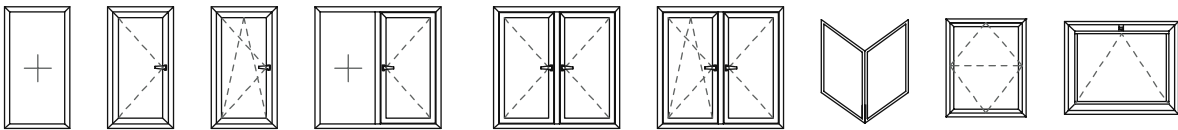

Kapı ve Pencere Sistemi
Door and Window System



WD70T

Soğuk iklim koşullarına dayanıklı olma özelliği ile dikkat çeken sistem.

Door and window system that has the feature of resistance to cold climate.



WD70T Yalıtımlı Kapı & Pencere Sistemi

WD70T Thermo Door & Window System

TEKNİK ÖZELLİKLER / TECHNICAL PROPERTIES

Kasa Geniřliđi / Frame Width	70-80,5 mm
Kanat Geniřliđi / Sash Width	77,5 mm
Isı Bariyeri / Thermal Break	24 mm
Profil Et Kalınlıđı / Profile Wall Thickness	1,5-2 mm
Min. Cam Kalınlıđı / Min. Glazing Thickness	16 mm
Maks. Cam Kalınlıđı / Max. Glazing Thickness	45 mm
Min. Kanat Ölçüleri / Min. Sash Dimensions	350 x 700 mm
Maks. Kanat Ölçüleri / Max. Sash Dimensions	1300 x 2800 mm
Maks. Kanat Ađırlıđı / Max. Sash Weight	130 kg

PERFORMANS DEđERİ / PERFORMANCE VALUES

EN 12152 Hava Geçirgenliđi / Air Permability	Class 3 (600 Pa)
EN 12154 Su Sızdırmazlıđı / Water Tightness	Class 9A (600 Pa)
EN 13830 Rüzgar Yüküne Dayanım / Wind Resistance	Class C3 (1200 Pa)
Min. Termal Isı Yalıtımı / Min. Thermal Insulation	Uf: 1,8-2,1 W/(m².K)

UYGULAMA SEÇENEKLERİ / APPLICATION OPTIONS

- İçe Açılır Kanat / Inward Opening Sash**
- Dışa Açılır Kanat / Outward Opening Sash**
- Çift Açılım / Tilt and Turn Opening**
- Vasistas Açılım / Transom Opening**
- Çift Kanat Açılım / Double Sash Opening**
- Pivot Açılım / Pivot Opening**

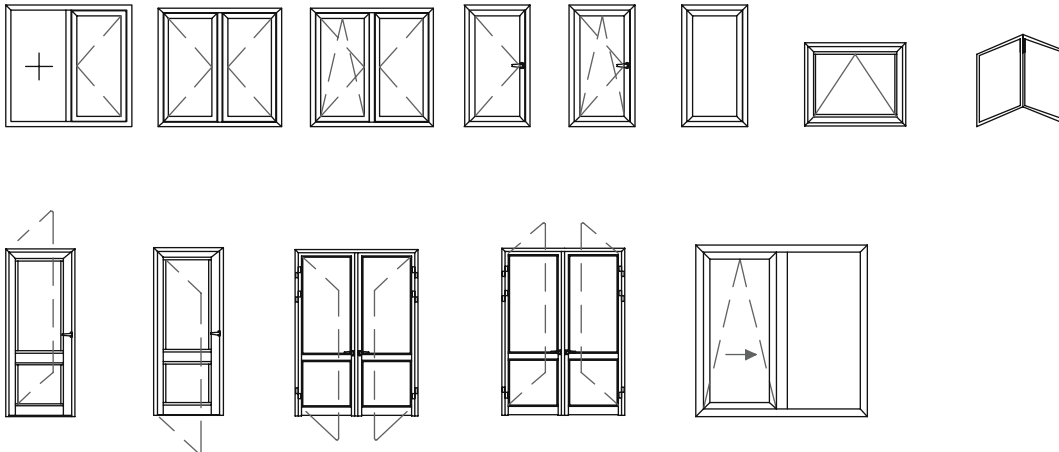

WD86T

- Kapı ve pencerelerde içe ve dışa açabilme imkanı,
- Ultra hava, akustik, ısı ve su tahliyesi,
- Hemyüz kapı-pencere çözümleri,
- Orta kayıtları çektirme bağlantı ve vida yoluyla bağlantı seçenekleri,
- Kanat içi ve sabit içinde orta kayıt alternatifleri,
- Açılı doğramalarda büküm normlarına uygun alternatif sağlayan kasa-kanat çeşitleri

- *Inward and outward opening options*
- *Very high air, sound and thermal insulation values*
- *Symmetrical sash and frame options*
- *Screwed and vertical mullion connections*
- *Ability to use mullions in sashes*
- *Frames and sashes can be bent for arch applications*



WD86T Yalıtımlı Kapı & Pencere Sistemi

WD86T Thermo Door & Window System

TEKNİK ÖZELLİKLER / TECHNICAL PROPERTIES

Kasa Geniřliđi / Frame Width	86 mm
Kanat Geniřliđi / Sash Width	86 mm
Isı Bariyeri / Thermal Break	34 mm
Profil Et Kalınlıđı / Profile Wall Thickness	2-3 mm
Min. Cam Kalınlıđı / Min. Glazing Thickness	26 mm
Maks. Cam Kalınlıđı / Max. Glazing Thickness	56 mm
Min. Kanat Ölçüleri / Min. Sash Dimensions	350 x 700 mm
Maks. Kanat Ölçüleri / Max. Sash Dimensions	1300 x 2800 mm
Maks. Kanat Ađırlıđı / Max. Sash Weight	130 kg

PERFORMANS DEđERİ / PERFORMANCE VALUES

EN 12152 Hava Geçirgenliđi / Air Permability	Class 4 - 600 Pa
EN 12154 Su Sızdırmazlıđı / Water Tightness	Class 9A - 600 Pa
EN 13830 Rüzgar Yüküne Dayanım / Wind Resistance	Class C4 - 1800 Pa
Min. Termal Isı Yalıtımı / Min. Thermal Insulation	Uf: 1,8 - 2,27 W/(m².K)

UYGULAMA SEÇENEKLERİ / APPLICATION OPTIONS

- İçe Açılır Kanat / Inward Opening Sash**
- Dışa Açılır Kanat / Outward Opening Sash**
- Çift Açılım / Tilt and Turn Opening**
- Vasistas Açılım / Transom Opening**
- Çift Kanat Açılım / Double Sash Opening**
- Pivot Açılım / Pivot Opening**

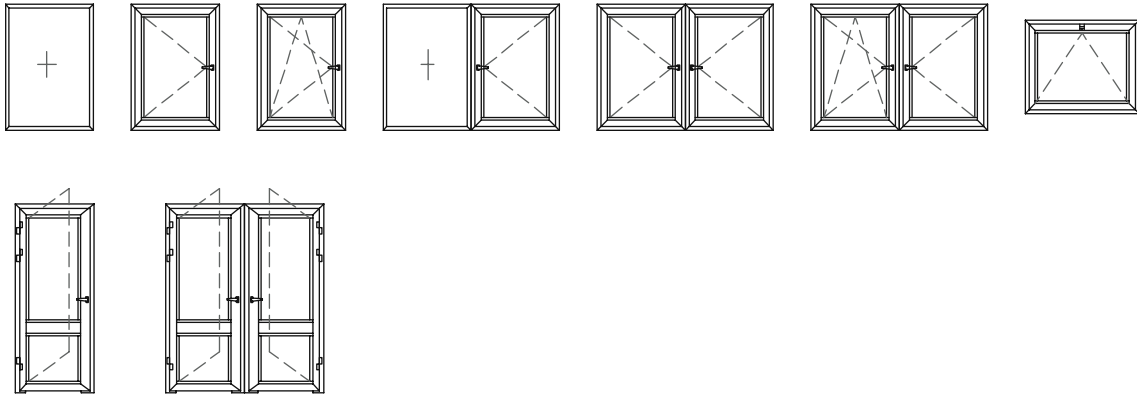

Kayar Katlanır Kapı Sistemi
Bi-Folding Door System



FD60T



Minimal estetiđi tasarım ile birleřtiren yalıtımlı FD60T kayar katlanır kapı sistemi, sorunsuz performans ve uzun ömürlü işlevsellik sunar.

Combining minimal aesthetics with design, the insulated FD60T bi-folding door system offers smooth performance and long-lasting functionality.

FD60T Kayar Katlanır Kapı Sistemi

FD60T Bi-Folding Door System

TEKNİK ÖZELLİKLER / TECHNICAL PROPERTIES

Kasa Geniřliđi / Frame Width	60 mm
Kanat Geniřliđi / Sash Width	60 mm
Isı Bariyeri / Thermal Break	15-20 mm
Profil Et Kalınlıđı / Profile Wall Thickness	1,5-2,5 mm
Min. Cam Kalınlıđı / Min. Glazing Thickness	4 mm
Maks. Cam Kalınlıđı / Max. Glazing Thickness	36 mm
Min. Kanat Ölçüleri / Min. Sash Dimensions	600 x 900 mm
Maks. Kanat Ölçüleri / Max. Sash Dimensions	900 x 2500 mm
Maks. Kanat Ađırlıđı / Max. Sash Weight	80 kg

PERFORMANS DEđERİ / PERFORMANCE VALUES

EN 12152 Hava Geçirgenliđi / Air Permability	Nt
EN 12154 Su Sızdırmazlıđı / Water Tightness	Nt
EN 13830 Rüzgar Yüküne Dayanım / Wind Resistance	Nt
Min. Termal Isı Yalıtımı / Min. Thermal Insulation	Uf: 3,27 W/(m ² .K)

UYGULAMA SEÇENEKLERİ / APPLICATION OPTIONS

- 3 , 5 , 7 ve 9 Kanatlı Katlanır Kapı / Sash Bi-folding Door
- 3+3 , 5+5 , 7+7 Kanatlı Katlanır Kapı / Sash Bi-folding Door
- 90° Dönüřlü Katlanır Kapı / Rotation Bi-folding Door

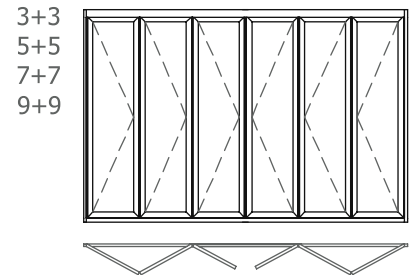
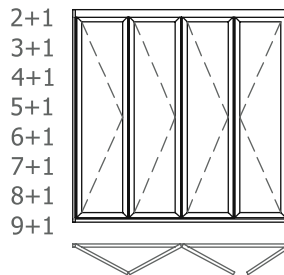
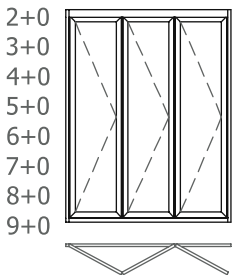

Kapı ve Pencere Sistemi
Door and Window System



HVT67 HVT77

Gizli Kanat / Hidden Vent

Dışarıdan görünmeyen kanat uygulaması imkanı sağlar.

It provides sash application possibility which is invisible from the outside.



HVT67 - HVT77 Gizli Kanat Kapı & Pencere Sistemi

HVT67 - HVT 77 Hidden Vent Door & Window System

TEKNİK ÖZELLİKLER / TECHNICAL PROPERTIES	HVT67	HVT77
Kasa Genişliği / Frame Width	67 mm	77 mm
Kanat Genişliği / Sash Width	69 mm	78,5 mm
Isı Bariyeri / Thermal Break	24 mm	34 mm
Profil Et Kalınlığı / Profile Wall Thickness	2 mm	2 mm
Min. Cam Kalınlığı / Min. Glazing Thickness	14 mm	24 mm
Maks. Cam Kalınlığı / Max. Glazing Thickness	26 mm	36 mm
Min. Kanat Ölçüleri / Min. Sash Dimensions	350 x 700 mm	350 x 700 mm
Maks. Kanat Ölçüleri / Max. Sash Dimensions	1300 x 2800 mm	1300 x 2800 mm
Maks. Kanat Ağırlığı / Max. Sash Weight	130 kg	130 kg

PERFORMANS DEĞERİ / PERFORMANCE VALUES

EN 12152 Hava Geçirgenliği / Air Permability	Class 4 (600 Pa)	Class 4 (600 Pa)
EN 12154 Su Sızdırmazlığı / Water Tightness	Class 9A (600 Pa)	Class 9A (600 Pa)
EN 13830 Rüzgar Yüküne Dayanım / Wind Resistance	Class C4 (1800 Pa)	Class C4 (1800 Pa)
Min. Termal Isı Yalıtımı / Min. Thermal Insulation	Uf: 2,20-2,37 W/(m ² .K)	Uf: 1,8-2,08 W/(m ² .K)

UYGULAMA SEÇENEKLERİ / APPLICATION OPTIONS

İçe Açılır Kanat / Inward Opening Sash	✓	✓
Dışa Açılır Kanat / Outward Opening Sash	✗	✗
Çift Açılım / Tilt and Turn Opening	✓	✓
Vasistas Açılım / Transom Opening	✓	✓
Çift Kanat Açılım / Double Sash Opening	✓	✓
Pivot Açılım / Pivot Opening	✓	✓

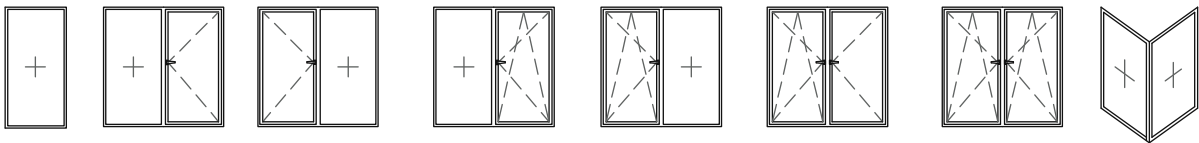

Sürme Sistemi
Sliding System



CS34

CS34 Her tip sürme pencere ve kapı için tam çözüm olanağı sunar.

CS34 offers a proper solution for all sliding door and window systems.

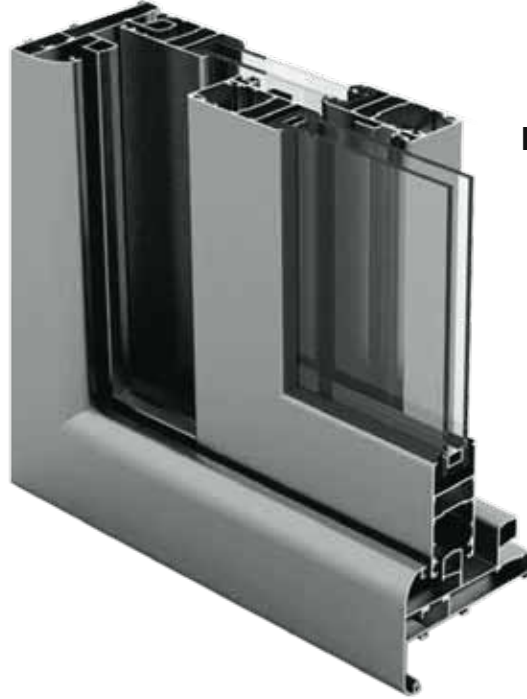

CS34 Yalıtımsız Sürme Sistemi

CS34 Uninsulated Sliding System

TEKNİK ÖZELLİKLER / TECHNICAL PROPERTIES

Kasa Derinliği / Frame Depth	90 - 131 mm
Kanat Derinliği / Sash Depth	34 mm
Kenet Derinliği / Interlocking Depth	79 mm
Profil Et Kalınlığı / Profile Wall Thickness	1,3 mm
Min. Cam Kalınlığı / Min. Glazing Thickness	4 mm
Maks. Cam Kalınlığı / Max. Glazing Thickness	20 mm
Min. Kanat Ölçüleri / Min. Sash Dimensions	800 x 1900 mm
Maks. Kanat Ölçüleri / Max. Sash Dimensions	1600 x 2800 mm
Maks. Kanat Ağırlığı / Max. Sash Weight	160 kg

PERFORMANS DEĞERİ / PERFORMANCE VALUES

EN 12152 Hava Geçirgenliği / Air Permability	-
EN 12154 Su Sızdırmazlığı / Water Tightness	-
EN 13830 Rüzgar Yüküne Dayanım / Wind Resistance	-
Min. Termal Isı Yalıtımı / Min. Thermal Insulation	-

UYGULAMA SEÇENEKLERİ / APPLICATION OPTIONS

- 90° Kanat Birleşimi / Sash Connection of 90°**
- 45° Kanat Birleşimi / Sash Connection of 45°**
- Cam Çıtalı Kanat / Sash With Glazing Bead**
- Cam Çıtasız Kanat / Sash Without Glazing Bead**
- Sineklik Uygulaması / Insect Screen Application**

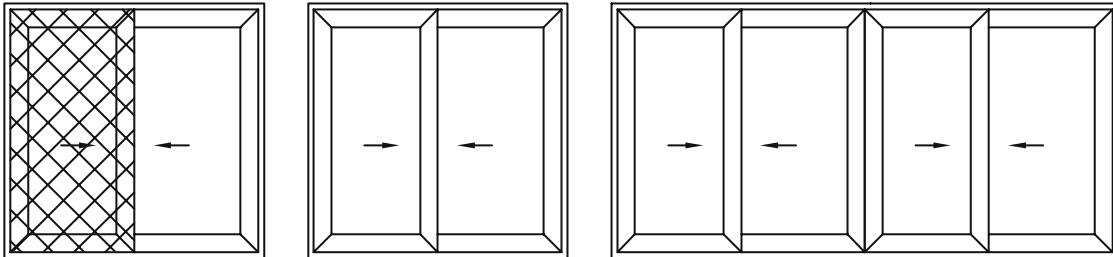

Sürme Sistemi
Sliding System



CS35T



CS35T sürme sistem, ferah bir ortam imkanı sağlar. Üstün taşıma kapasitesi sayesinde hızlı hareket eden kanatlarla üstün konfor sağlamaktadır.

CS35T The sliding system provides a spacious environment. Thanks to its superior carrying capacity, it provides comfort with fast moving sashes.

CS35T Yalıtımlı Sürme Sistemi

CS35T Thermo Sliding System

TEKNİK ÖZELLİKLER / TECHNICAL PROPERTIES

Kasa Derinliği / Frame Depth	82 - 160 mm
Kanat Derinliği / Sash Depth	39 mm
Kenet Derinliği / Interlocking Depth	89 mm
Profil Et Kalınlığı / Profile Wall Thickness	1,3 - 1,5 mm
Isı Bariyeri / Thermal Break	18 - 24 mm
Cam Kalınlığı / Glazing Thickness	20 mm
Min. Kanat Ölçüleri / Min. Sash Dimensions	800 x 1900 mm
Maks. Kanat Ölçüleri / Max. Sash Dimensions	1600 x 2800 mm
Maks. Kanat Ağırlığı / Max. Sash Weight	160 kg

PERFORMANS DEĞERİ / PERFORMANCE VALUES

EN 12152 Hava Geçirgenliği / Air Permability	-
EN 12154 Su Sızdırmazlığı / Water Tightness	-
EN 13830 Rüzgar Yüküne Dayanım / Wind Resistance	-
Min. Termal Isı Yalıtımı / Min. Thermal Insulation	Uf: 5,49 - 6,24 W/(m².K)

UYGULAMA SEÇENEKLERİ / APPLICATION OPTIONS

90° Kanat Birleşimi / Sash Connection of 90°



45° Kanat Birleşimi / Sash Connection of 45°



Cam Çıtalı Kanat / Sash With Glazing Bead



Cam Çıtasız Kanat / Sash Without Glazing Bead



Sineklik Uygulaması / Insect Screen Application

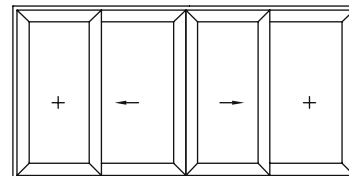
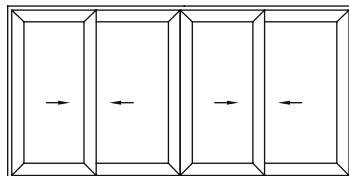
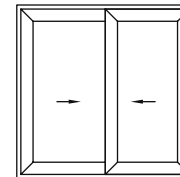
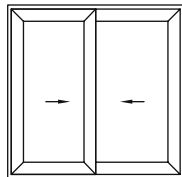
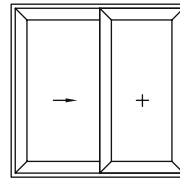
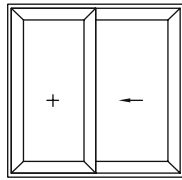

Kaldır - Sür Sistemi Lift & Slide System



HS55T



HS55T sistemi, kaldır-sür pencere ve kapı tipleri için tam çözüm olanağı sağlar. Otomatik kaldır-sür mekanizma kullanım olanağı mevcuttur. Yüksek hava, su, rüzgar yalıtımı sağlar.

The system is a proper solution for a lift&slide door and window systems. The HS55T system offers option to use automatic lift & slide mechanism. It provides high air, water and wind insulation.

HS55T Kaldır - Sür Sistemi

HS55T Lift & Slide System

TEKNİK ÖZELLİKLER / TECHNICAL PROPERTIES

Kasa Derinliği / Frame Depth	125 mm
Kanat Derinliği / Sash Depth	55 mm
Kenet Derinliği / Interlocking Depth	125 mm
Profil Et Kalınlığı / Profile Wall Thickness	1,5 - 2 mm
Isı Bariyeri / Thermal Break	12 - 20 mm
Min. Cam Kalınlığı / Min. Glazing Thickness	4 mm
Maks. Cam Kalınlığı / Max. Glazing Thickness	36 mm
Min. Kanat Ölçüleri / Min. Sash Dimensions	800 x 1900 mm
Maks. Kanat Ölçüleri / Max. Sash Dimensions	2600 x 3000 mm
Maks. Kanat Ağırlığı / Max. Sash Weight	400 kg

PERFORMANS DEĞERİ / PERFORMANCE VALUES

EN 12152 Hava Geçirgenliği / Air Permability	A4 - 600 Pa
EN 12154 Su Sızdırmazlığı / Water Tightness	RE 1200 Pa
EN 13830 Rüzgar Yüküne Dayanım / Wind Resistance	1200 Pa
Min. Termal Isı Yalıtımı / Min. Thermal Insulation	Uf: 4,51 W/(m².K)

UYGULAMA SEÇENEKLERİ / APPLICATION OPTIONS

- 90° Kanat Birleşimi / Sash Connection of 90°**
- 45° Kanat Birleşimi / Sash Connection of 45°**
- Cam Çıtalı Kanat / Sash With Glazing Bead**
- Cam Çıtasız Kanat / Sash Without Glazing Bead**
- Sineklik Uygulaması / Insect Screen Application**

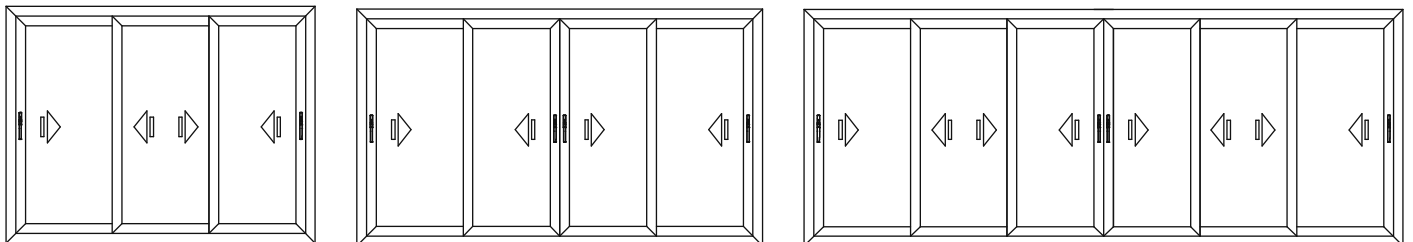
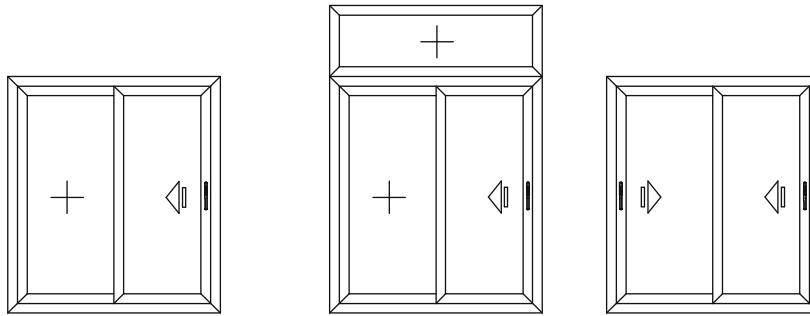

Sürme Sistemi
Sliding System



S35 / S35T

NOVO LINE

**Çelik ray ve rulman uygulaması
ile 160 kg'a kadar kanat
taşıma kapasitesine sahiptir.**

*The system has sash carrying
capacity up to 160 kg with
steel rail and roller application.*



S35 Yalıtımsız Novoline Sürme Sistemi

S35 Uninsulated Novoline Sliding System

S35T Yalıtımlı Novoline Sürme Sistemi

S35T Thermo Novoline Sliding System

TEKNİK ÖZELLİKLER / TECHNICAL PROPERTIES	S35 YALITIMSIZ Uninsulated	S35T YALITIMLI Insulated
Kasa Derinliği / Frame Depth	85 - 130 mm	96 - 157,5 mm
Kanat Derinliği / Sash Depth	35 mm	35 mm
Kenet Derinliği / Interlocking Depth	80 - 152 mm	85 - 157 mm
Profil Et Kalınlığı / Profile Wall Thickness	1,3 - 1,5 mm	1,3 - 1,5 mm
Isı Bariyeri / Thermal Break	-	12 - 18 mm
Min. Cam Kalınlığı / Min. Glazing Thickness	20 mm	20 mm
Maks. Cam Kalınlığı / Max. Glazing Thickness	22 mm	22 mm
Min. Kanat Ölçüleri / Min. Sash Dimensions	800 x 1900 mm	800 x 1900 mm
Maks. Kanat Ölçüleri / Max. Sash Dimensions	1600 x 2800 mm	1600 x 2800 mm
Maks. Kanat Ağırlığı / Max. Sash Weight	160 kg	160 kg

PERFORMANS DEĞERİ / PERFORMANCE VALUES

EN 12152 Hava Geçirgenliği / Air Permeability	-	A4 - 600 Pa
EN 12154 Su Sızdırmazlığı / Water Tightness	-	RE 900 Pa
EN 13830 Rüzgar Yüküne Dayanım / Wind Resistance	-	800 Pa
Min. Termal Isı Yalıtımı / Min. Thermal Insulation	-	Uf: 3,33- 4,99 W/(m².K)

UYGULAMA SEÇENEKLERİ / APPLICATION OPTIONS

90° Kanat Birleşimi / Sash Connection of 90°



45° Kanat Birleşimi / Sash Connection of 45°



Cam Çıtalı Kanat / Sash With Glazing Bead



Cam Çıtasız Kanat / Sash Without Glazing Bead



Sineklik Uygulaması / Insect Screen Application

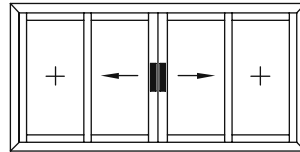
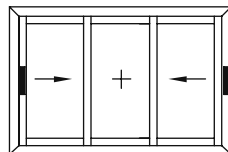
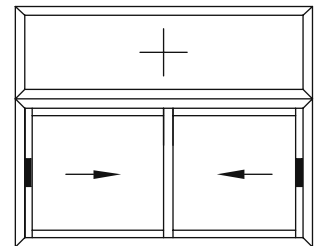
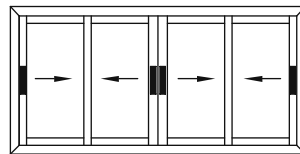
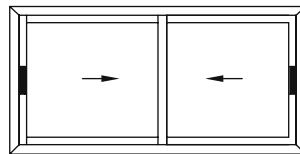
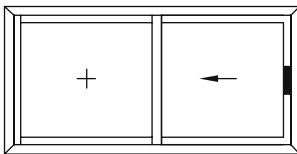

Sürme Sistemi
Sliding System



S38T

**Orta ve geniş açıklıklar için uygun sistem.
Alternatifli sürme tipleri için ideal çözümler.**

*Suitable for medium and large openings.
Ideal solutions for all kind of sliding systems.*

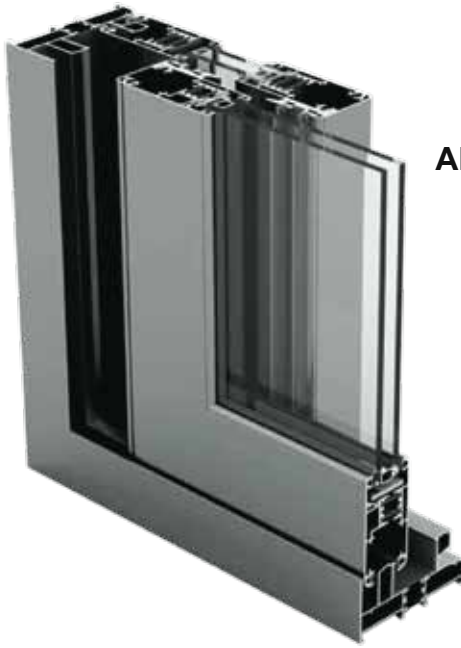

S38T Yalıtımlı Sürme Sistemi

S38T Thermo Sliding System

TEKNİK ÖZELLİKLER / TECHNICAL PROPERTIES

Kasa Derinliği / Frame Depth	94 - 155,5 mm
Kanat Derinliği / Sash Depth	38 mm
Kenet Derinliği / Interlocking Depth	88 mm
Profil Et Kalınlığı / Profile Wall Thickness	1,3 - 1,5 mm
Isı Bariyeri / Thermal Break	12 - 18 mm
Min. Cam Kalınlığı / Min. Glazing Thickness	6 mm
Maks. Cam Kalınlığı / Max. Glazing Thickness	22 mm
Min. Kanat Ölçüleri / Min. Sash Dimensions	800 x 1900 mm
Maks. Kanat Ölçüleri / Max. Sash Dimensions	1600 x 2800 mm
Maks. Kanat Ağırlığı / Max. Sash Weight	160 kg

PERFORMANS DEĞERİ / PERFORMANCE VALUES

EN 12152 Hava Geçirgenliği / Air Permability	A4 - 600 Pa
EN 12154 Su Sızdırmazlığı / Water Tightness	RE 900 Pa
EN 13830 Rüzgar Yüküne Dayanım / Wind Resistance	800 Pa
Min. Termal Isı Yalıtımı / Min. Thermal Insulation	Uf: 5,14 - 6,86 W/(m².K)

UYGULAMA SEÇENEKLERİ / APPLICATION OPTIONS

- 90° Kanat Birleşimi / Sash Connection of 90°**
- 45° Kanat Birleşimi / Sash Connection of 45°**
- Cam Çıtalı Kanat / Sash With Glazing Bead**
- Cam Çıtasız Kanat / Sash Without Glazing Bead**
- Sineklik Uygulaması / Insect Screen Application**

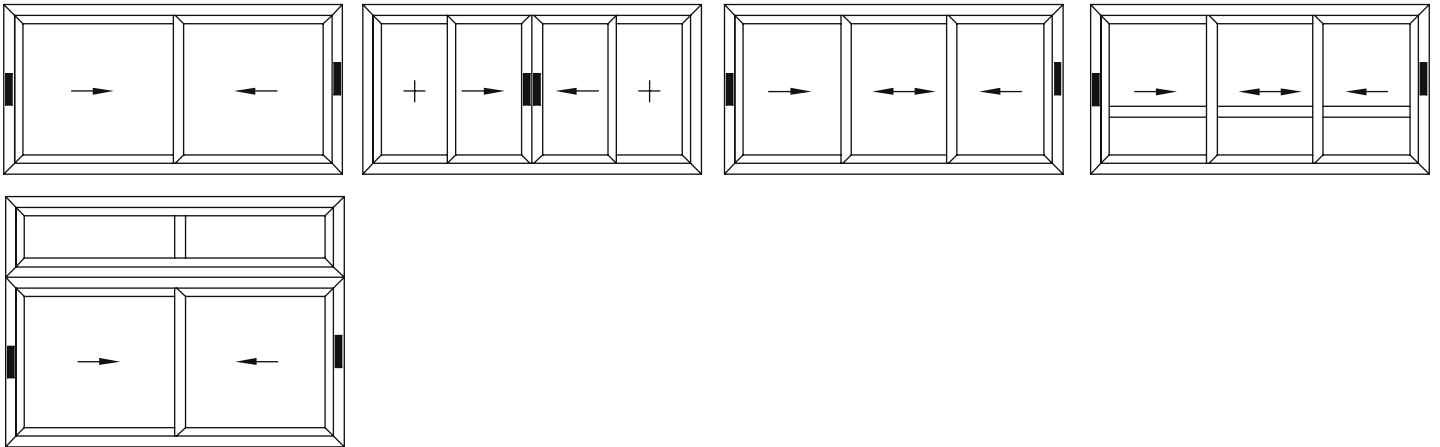

Cephe Sistemi Facade System

FS50

Yüksek katlı yapıların dış cephelerinde tamamen cam ve şeffaf görüntü imkanı sağlamayı başaran giydirme cephe sistemidir.

STRÜKTÜREL SİLİKON CEPHE
Structural Facade



ECO FS50

The curtain wall system that succeeds in providing complete glass and transparent view on the exteriors of high-rise buildings.

SİLİKON CEPHE ECO
Stick Facade



FS50 Cephe Sistemi

FS50 Facade System

TEKNİK ÖZELLİKLER / TECHNICAL PROPERTIES

	FS50 ECO	FS50
Profil Geniřliđi / Profile Width	50 mm	50 mm
Profil Et Kalınlıđı / Profile Wall Thickness	1,6 - 2 mm	1,4 - 2,5 mm
Düřey Tařıyıcı Profil Derinliđi / Mullion Profile Depth	60 - 150 mm	50-180 mm
Yatay Tařıyıcı Profil Derinliđi / Transom Profile Depth	60 - 150 mm	30-126 mm
Min. Cam Kalınlıđı / Min. Glazing Thickness	20 mm	4 mm
Maks. Cam Kalınlıđı / Max. Glazing Thickness	34 mm	45 mm
Min. Kanat Boyut / Min. Sash Dimension	700 - 1200 mm	700 x 1200 mm
Maks. Kanat Boyut / Max. Sash Dimension	1500 - 2000 mm	1500 x 2000 mm
Maks. Kanat Ađırlıđı / Max. Sash Weight	155 kg	155 kg

PERFORMANS DEĐERİ / PERFORMANCE VALUES

EN 12152 Hava Geçirgenliđi / Air Permeability	A4 - 600 Pa	A4 - 600 Pa
EN 12154 Su Sızdırmazlıđı / Water Tightness	RE 1200 Pa	RE 1200 Pa
EN 13830 Rüzgar Yüküne Dayanım / Wind Resistance	1200 Pa	1200 Pa
Min. Termal Isı Yalıtımı / Min. Thermal Insulation	Uf: 3,45 W/(m².K)	Uf: 2,64 - 3,88 W/(m².K)

UYGULAMA SEÇENEKLERİ / APPLICATION OPTIONS

Dıřa Açılır Ters Vasistas Gizli Kanat / Outward Opening Hidden Transom Sash	✓	✓
Kapaklı Cephe / Covered Facade	✓	✓
Silikon Cephe / Stick Facade	✓	✓
Yarı Kapaklı Cephe / Half - Covered Facade	✓	✓
Kasetli Silikon Cephe / Cassette Stick Facade	✓	✓

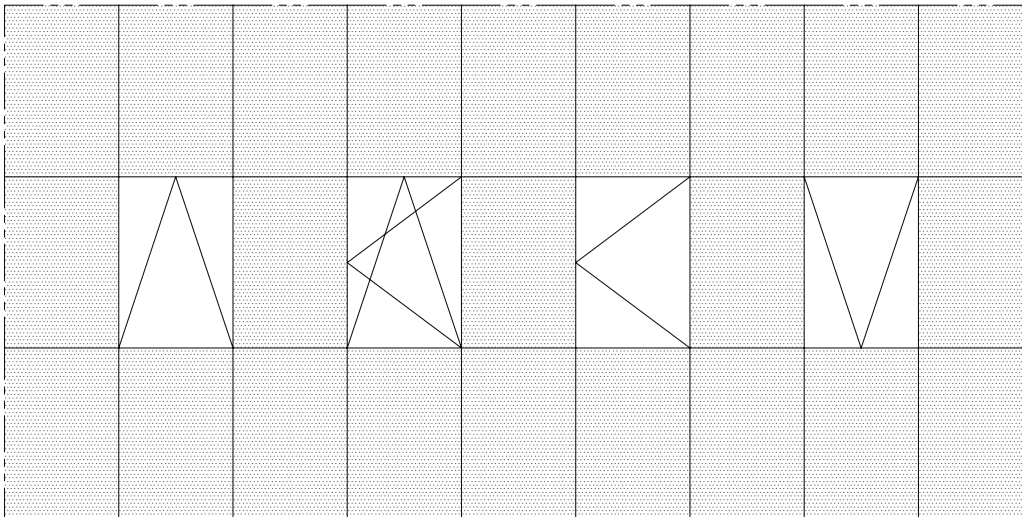

Çelik Takviyeli Cephe Sistemi Steel Reinforced Facade System



FS65

Yüksek katlı yapıların dış cephelerinde tamamen cam ve şeffaf görüntü imkanı sağlamayı başaran sistem.

The system that succeeds in providing complete glass and transparent view on the exteriors of high-rise buildings.



FS65 Çelik Takviyeli Cephe Sistemi

FS65 Steel Reinforced Facade System

TEKNİK ÖZELLİKLER / TECHNICAL PROPERTIES

Profil Genişliği / Profile Width	65 mm
Profil Et Kalınlığı / Profile Wall Thickness	1,8 - 2,5 mm
Düsey Taşıyıcı Profil Yüksekliği / Mullion Profile Height	84 mm
Yatay Taşıyıcı Profil Yüksekliği / Transom Profile Height	84 mm
Düsey Taşıyıcı Maks. Çelik Ölçüsü / Mullion Max. Steel Dimension	150 x 40 mm
Yatay Taşıyıcı Maks. Çelik Ölçüsü / Transom Max. Steel Dimension	150 x 40 mm
Cam Kalınlığı / Glazing Thickness	10 - 45 mm

UYGULAMA SEÇENEKLERİ / APPLICATION OPTIONS

- Dışa-İçe Açılır Kanat Uygulaması / Outward-Opening Sash Application
- Kapaklı Cephe / Covered Facade
- Silikon Cephe / Stick Facade
- Yarı Kapaklı Cephe / Half - Covered Facade
- Kasetli Silikon Cephe / Cassette Stick Facade

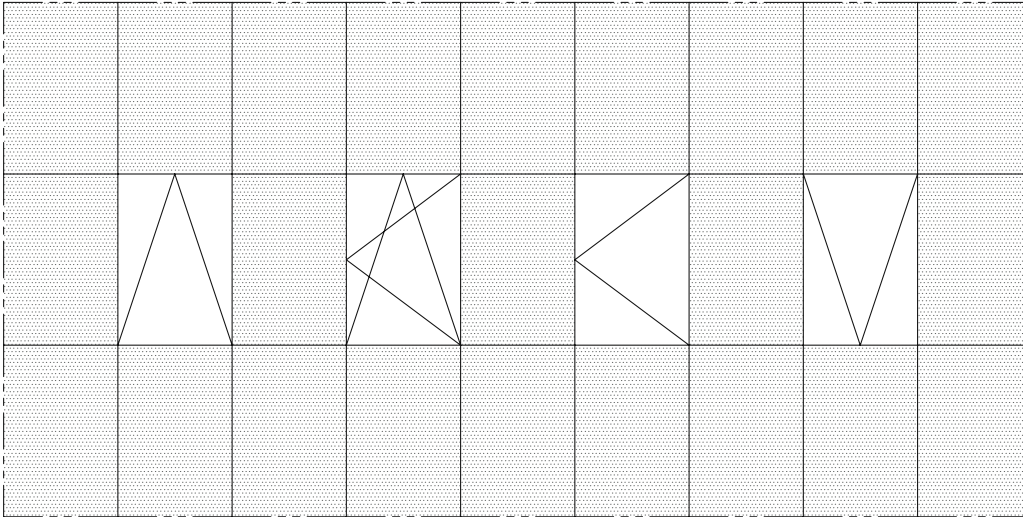

Cotta Cephe Sistemi
Cotta Facade System



AC22

Uzun ömürlüdür.
Estetik görünüm sağlar.
Bakım ve temizlik gerektirmez.

It is durable.
It provides an aesthetic appearance.
*It does not require maintenance
and cleaning.*



AC22 Cotta Cephe Sistemi

AC22 Cotta Facade System

TEKNİK ÖZELLİKLER / TECHNICAL PROPERTIES

Profil Geniřliđi / Profile Width	22 mm
Profil Et Kalınlıđı / Profile Wall Thickness	1,6 mm
Düřey Tařıyıcı Profil Yüksekliđi / Mullion Profile Height	150 - 218 mm

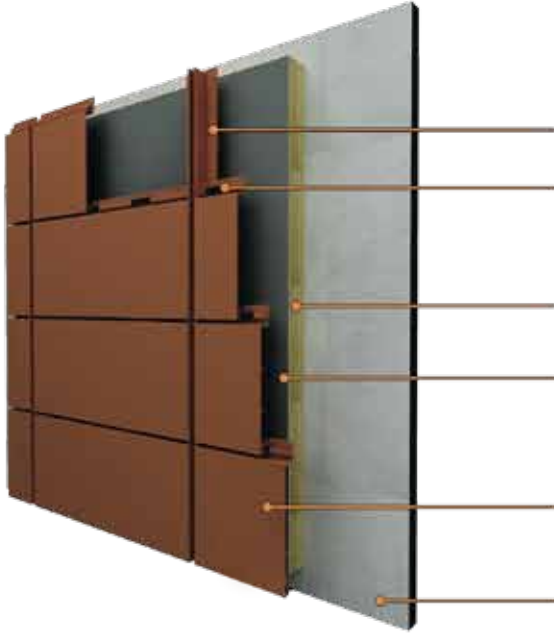

Derz Kanallı Tařıyıcı Profili
Grooved Mullion Profile
EPDM U Fiteli / EPDM U Gasket

Tař Yünü / Rock Wool
Membran / Membrane

Cotta Lambiri Profili (250 mm)
Cotta Panel Profile (250 mm)

Duvar / Wall



Tařıyıcı Profili / Mullion Profile
L Ankraj / L Anchorage
Membran / Membrane
EPDM U Fiteli / EPDM U Gasket
Tař Yünü / Rock Wool

Cotta Lambiri Profili (150 mm)
Cotta Panel Profile (150 mm)

Duvar / Wall

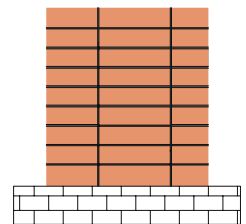
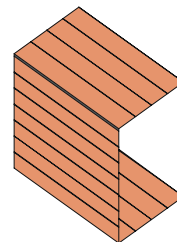
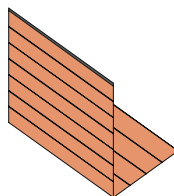
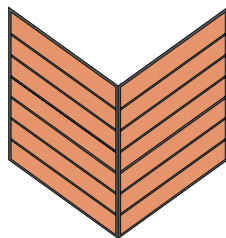
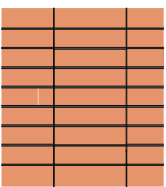

Iřıklık Sistemi
Skylight System



SKY65

Doęal iřığı kullanarak aydınlık mekanlar oluşturmak için dizayn edilen sistemdir.

It is designed to create bright spaces using sun light.

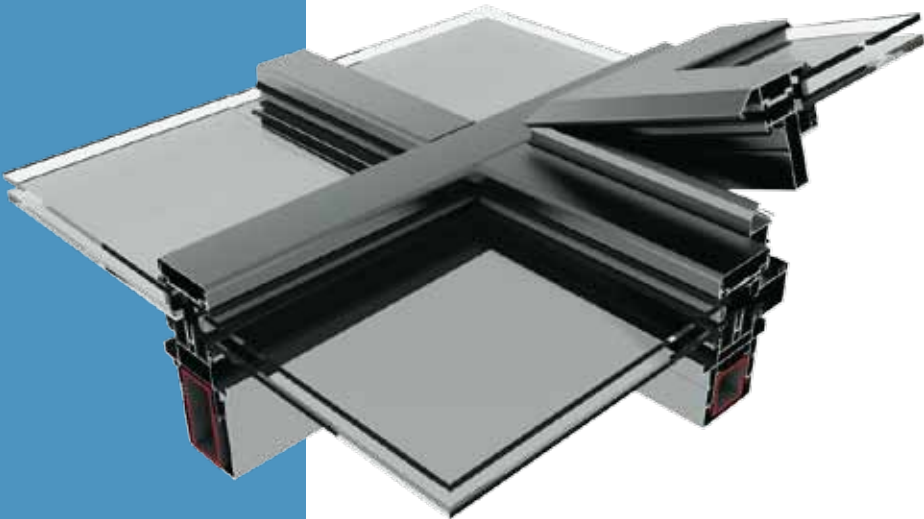

SKY65 Işıklık Sistemi

SKY65 Skylight System

TEKNİK ÖZELLİKLER / TECHNICAL PROPERTIES

Profil Geniřliđi / Profile Width	65 mm
Profil Et Kalınlıđı / Profile Wall Thickness	1,8 - 2,5 mm
Düřey Tařıyıcı Profil Yüksekliđi / Mullion Profile Height	81 mm
Yatay Tařıyıcı Profil Yüksekliđi / Transom Profile Height	81 mm
Düřey Tařıyıcı Maks. Çelik Ölçüsü / Mullion Max. Steel Dimension	140 x 40 mm
Yatay Tařıyıcı Maks. Çelik Ölçüsü / Transom Max. Steel Dimension	140 x 40 mm
Cam Kalınlıđı / Glazing Thickness	10 - 45 mm

UYGULAMA SEÇENEKLERİ / APPLICATION OPTIONS

- Dıřa Açılır Motorlu Kanat Uygulaması / Outward-Opening Motorized Sash Application** ✓
- Kapaklı Cephe / Covered Facade** ✓
- Silikon Cephe / Stick Facade** ✓
- Yarı Kapaklı Cephe / Half - Covered Facade** ✓
- Kasetli Silikon Cephe / Cassette Stick Facade** ✓

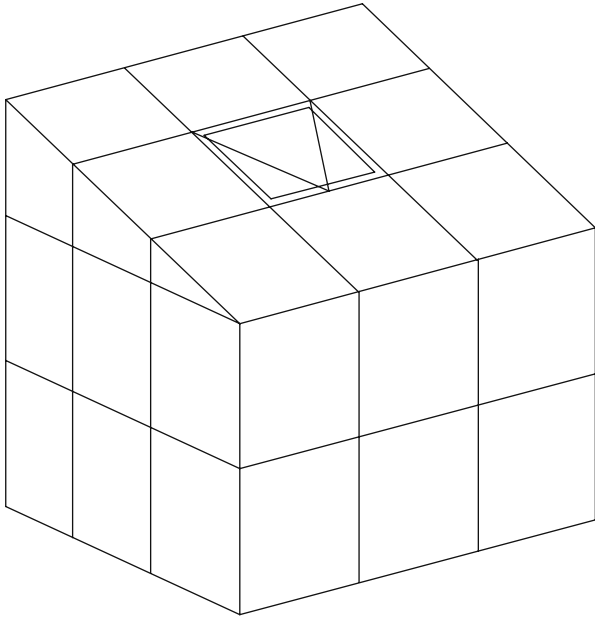

Güneş Kırıcı Sistem Sun Breaker System



SB

Cepheye gelen dik güneş ışınlarının açısını ve yönünü değiştirmek için kullanılan sistemdir.

It is used to change the angle and the direction of the sunlight coming right to the facade.



SB Güneş Kırıcı Sistemi

SB Sun Breaker System

TEKNİK ÖZELLİKLER / TECHNICAL PROPERTIES

Badem Form Profil Genişliği / Convex Form Profile Width	40 - 300 mm
Eklemeli Badem Form Profil Genişliği / Convex Form Profile Width With Extension	350 - 400 mm
Dış Cephe Kapak Form Profil Genişliği / Exterior Cover Form Profile Width	80 - 300 mm
Profil Et Kalınlığı / Profile Wall Thickness	1 - 2,4 mm
Profil Derinliği / Profile Depth	50 - 22 mm
Eksiz Profil Uygulama Uzunluğu / Profile Application Length Without Extension	Ort . 1500 mm

UYGULAMA SEÇENEKLERİ / APPLICATION OPTIONS

Yatay Uygulama / Horizontal Application



Dikey Uygulama / Vertical Application



Sabit Uygulama / Fixed Application

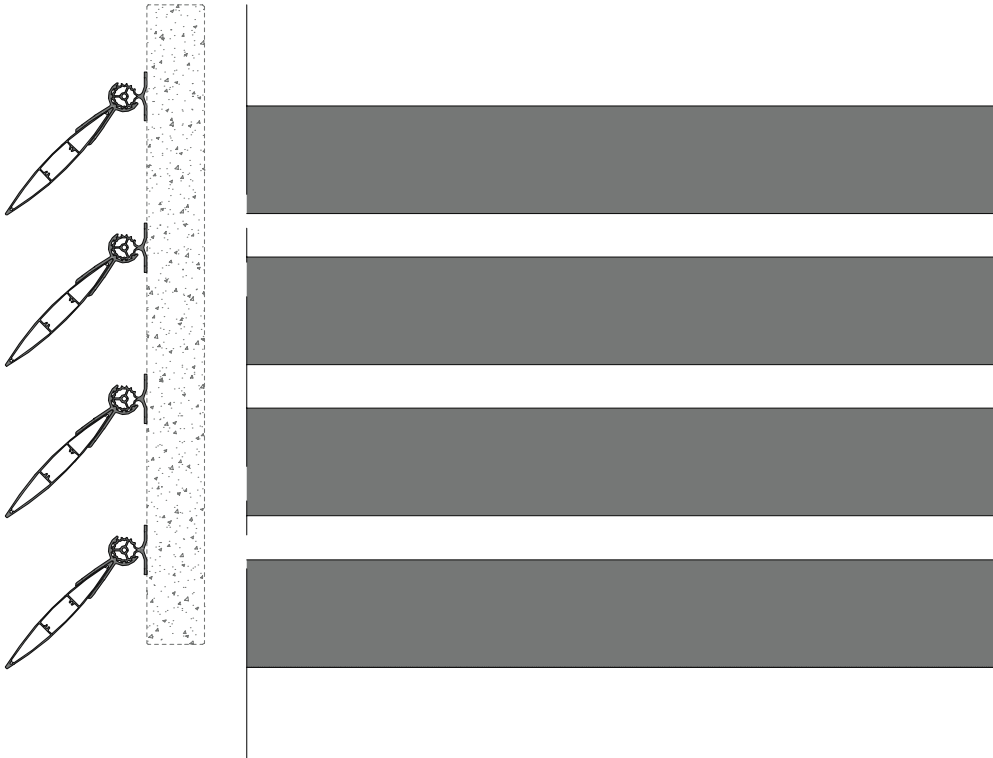

Ayarlı Kapı Sistemi Adjustable Door System



AD40



Farklı duvar kalınlıklarına göre tercih edebileceğiniz ve ahşap, camlı ya da çerçevesiz kapılarda uygulanabilir bir sistemdir.

The system that can be applied to different ranges of wall thickness with a wooden, glass or framed door opportunities.

AD40 Ayarlı Kapı Sistemi

AD40 Adjustable Door System



Kapı Uygulaması İçin Çita Seçenekleri / Bead Options For Door Application

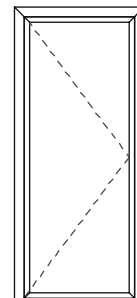
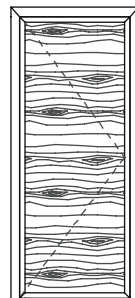
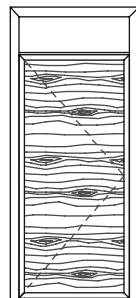
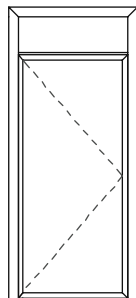

Ofis Bölme Sistemi
Office Partition System



OP40 OP100

Ofislerde farklı alanlar oluşturmak için tercih edilen, sesi minimize edebilen, şık görünümü ve kullanışlı yapısıyla dikkatleri üzerine çekmeyi başaran sistem.

A system that can be used to create different areas in offices, it draws attention with its stylish look while also minimizing the sound.

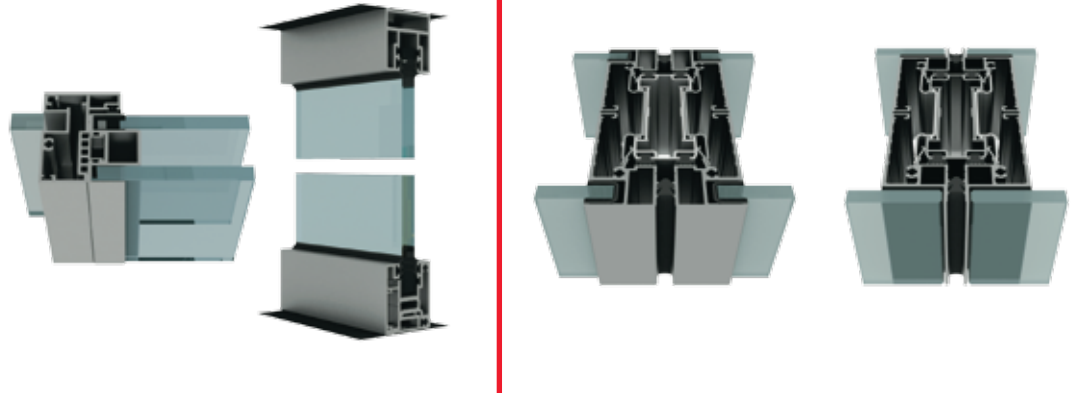

OP40 / OP100 Ofis Bölme Sistemi

OP40 / OP100 Office Partition System

TEKNİK ÖZELLİKLER / TECHNICAL PROPERTIES

	OP40 Tek Camlı / Single Glazed	OP40 Çift Camlı / Double Glazed
Kapı Kasa Derinliği / Door Frame Depth	40 mm	100 mm
Cam Uygulama / Glazing Application	8-10-12-14 mm	8-10-12-14 mm
Cam Genişliği / Glazing Width	600 mm - 1500 mm	600 mm - 1500 mm
Cam Yüksekliği / Glazing Height	2000 mm - 3500 mm	2000 mm - 3500 mm
Ses Yalıtım / Sound Insulation	52 dB	48 dB

UYGULAMA SEÇENEKLERİ / APPLICATION OPTIONS

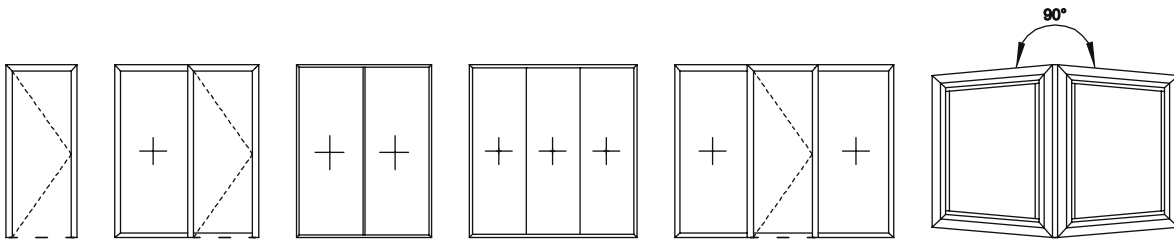

TEKNİK ÖZELLİKLER / TECHNICAL PROPERTIES

	OP100 Yapıştırma Camlı Model Cohesive Glass Model	OP100 Çerçevesiz Camlı Model Framed Glass Model
Kapı Kasa Derinliği / Door Frame Depth	100 mm	100 mm
Cam Uygulama / Glazing Application	4-6 mm	10 mm
Cam Genişliği / Glazing Width	600 mm - 1500 mm	600 mm - 1500 mm
Cam Yüksekliği / Glazing Height	2000 mm - 3500 mm	2000 mm - 3500 mm
Ses Yalıtım / Sound Insulation	45 dB	45 dB
İki Cam Arası Jaluzi uygulayabilme Possibility to apply blinds between glasses	✓	✓

UYGULAMA SEÇENEKLERİ / APPLICATION OPTIONS

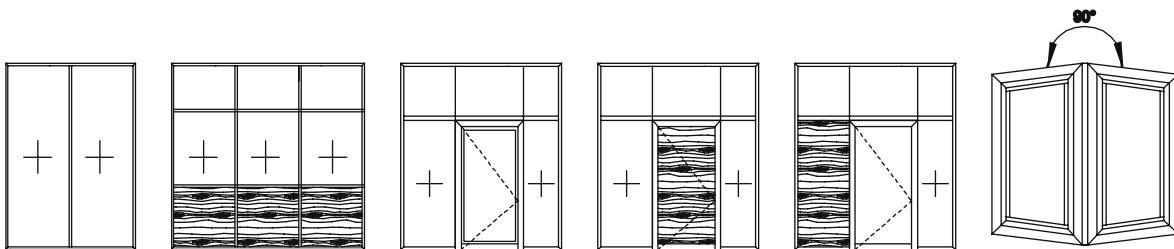

Loft Sistemleri
Loft Systems



MF20
KATLANIR
FOLDING

OP30
SABİT
FIX

MS20
SÜRME
SLIDING



Loft Sistemleri

Loft Systems

LOFT MF20 TEKNİK ÖZELLİKLER / TECHNICAL PROPERTIES

Çerçeve Ebatları / Frame Dimensions	40 mm x 22 mm
Cam Uygulama / Glazing Application	4+4 mm
Üst Taşıyıcı Ray Ebatları / Top Carrier Rail Dimensions	50+40 mm x 58 mm
Kılavuzlama Durumu / Guide Type	Zemine gömme raylı
Entegreli Çalışma I / Integrated Work I	✓
Maks. Kanat Ölçüleri / Max. Sash Dimensions	700 x 2500 mm
Maks. Kanat Ağırlığı / Max. Sash Weight	40 kg

LOFT OP30 TEKNİK ÖZELLİKLER / TECHNICAL PROPERTIES

Çerçeve Ebatları / Frame Dimensions	40 mm x 30 mm
Cam Uygulama / Glazing Application	4+4 mm
Entegreli Çalışma I / Integrated Work I	✓
Entegreli Çalışma II / Integrated Work II	✓
Karolajlı Uygulama / Decorative Grid Application	✓

LOFT MS20 TEKNİK ÖZELLİKLER / TECHNICAL PROPERTIES

Çerçeve Ebatları / Frame Dimensions	40 mm x 20 mm
Cam Uygulama / Glazing Application	4+4 mm
Üst Taşıyıcı Ray Ebatları / Top Carrier Rail Dimensions	50+40 mm x 36 mm
Kılavuzlama Durumu / Guide Type	Zeminde hizalama parçalı
Entegreli Çalışma II / Integrated Work II	✓
Maks. Kanat Ölçüleri / Max. Sash Dimensions	1200 x 2500 mm
Maks. Kanat Ağırlığı / Max. Sash Weight	70 kg

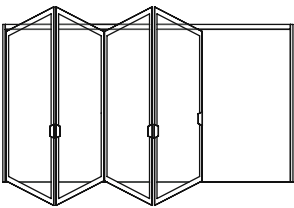

LOFT SİSTEM
MF20

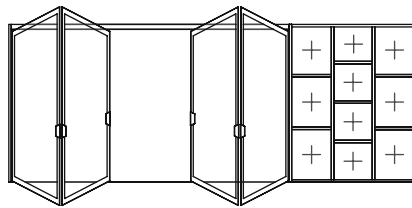

LOFT SİSTEM
MF20 / OP30

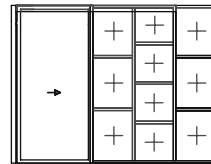

LOFT SİSTEM
MS20 / OP30

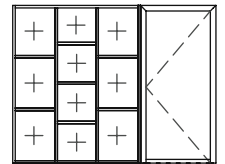

LOFT SİSTEM
OP30



Kış Bahçesi Sistemi
Winter Garden System



WG70 WG70T

Konfor ve estetiği bir araya getiren ve farklı açılı alternatifleri sunan sistem

The system that combines comfort and aesthetics which provides different angle alternatives



WG70 Yalıtımsız Kış Bahçesi Sistemi

WG70 Uninsulated Winter Garden System

WG70T Yalıtımlı Kış Bahçesi Sistemi

WG70T Thermo Winter Garden System

TEKNİK ÖZELLİKLER / TECHNICAL PROPERTIES

	WG70	WG70T
Dikme Profil Geniřliđi / Pole Profile Width	110 mm	123 mm
Oluk Profil Geniřliđi / Gutter Profile Width	176 mm	104 mm
Tařıyıcı Profil Geniřliđi / Glazing Carrier Profile Width	55 mm	82 - 113 mm
Profil Et Kalınlıđı / Profile Wall Thickness	1,4 - 3,6 mm	1,5 - 3 mm
Maks. Cam Kalınlıđı / Max. Glazing Thickness	16 mm	32 mm
Maks. Cam Geniřliđi / Max. Glazing Width	820 mm	820 mm
Eksiz Maks. Veranda Geniřliđi / Max. Jointless Veranda Width	4500 mm	4500 mm
Maks. Veranda Derinliđi / Max. Veranda Depth	3500 mm	3500 mm
İki Dikme Arası Maks. Mesafe / Max. Distance Between Pole Profiles	4500 mm	4500 mm
Veranda Maks. Arka Yükseklik / Max. Veranda Back Height	3000 mm	3000 mm
Veranda Maks. Ön Yükseklik / Max. Veranda Front Height	2500 mm	2500 mm
Min. Termal Isı Yalıtımı / Min. Thermal Insulation	-	Uf: 1,85 W/(m ² .K)

UYGULAMA SEÇENEKLERİ / APPLICATION OPTIONS

Oluk Takviye / Gutter Reinforcement



Tařıyıcı Takviye / Carrier Reinforcement



Düz Veranda (Ekli - Eksiz) / Straight Veranda (Joint - Jointless)



L tipi Veranda / L Type Veranda

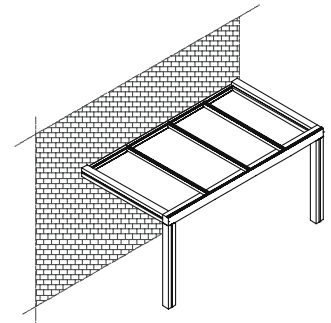
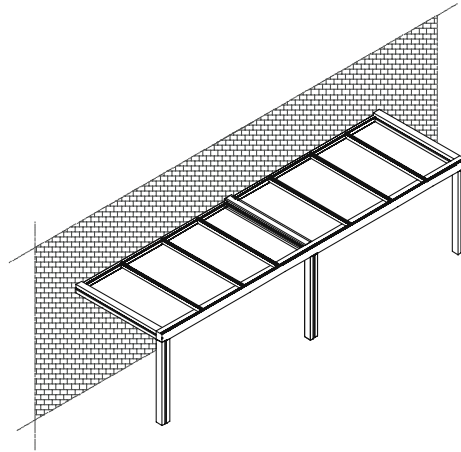
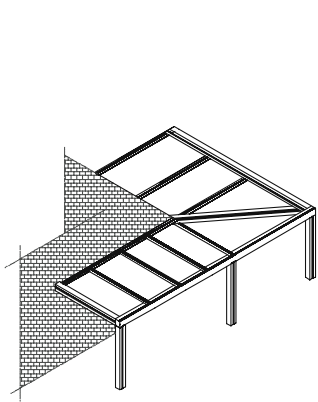

Motorlu Giyotin Sistemi
Motorized Guillotine System



SH110

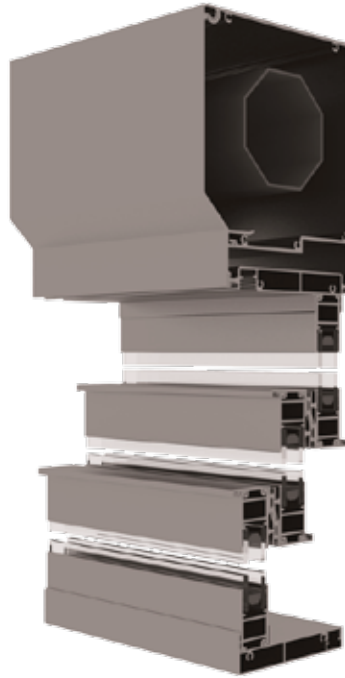

**Şık ve modern tasarım ile dikkatleri
üzerine toplayan system,
kesintisiz manzara imkanı sunar.**

*The system that attracts attention
with its stylish and modern design,
also offers an uninterrupted view.*

SH110 Motorlu Giyotin Sistemi

SH110 Motorized Guillotine System

TEKNİK ÖZELLİKLER / TECHNICAL PROPERTIES

Üst Kutu Profil Genişliği / Top Tube Profile Width	134 mm
Üst Kutu Profil Yüksekliği / Top Tube Profile Height	170 mm
Kanat Profil Genişliği / Sash Profile Width	25 mm
Kanat Profil Yüksekliği / Sash Profile Height	38 mm
Profil Et Kalınlığı / Profile Wall Thickness	2,5 - 1,3 mm
Cam Kalınlığı / Glazing Thickness	8 - 20 mm
Maks. Kanat Genişliği / Max. Sash Width	3500 mm
Maks. Kanat Yüksekliği / Max. Sash Height	1000 mm
Maks. Kanat Ağırlığı / Max. Sash Weight	70 kg
Maks. Kanat Sayısı / Max. Sash Number	4

UYGULAMA SEÇENEKLERİ / APPLICATION OPTIONS

Üst Küpeşteli, Alt Eşikli Sistem

Top Handrail, Bottom Threshold System



Üst Küpeştersiz, Alt Eşikli Sistem

Without Top Handrail, Bottom Threshold System



Üst Küpeşteli, Alt Eşiksiz Sistem

Top Handrail, Without Bottom Threshold System



Üst Küpeştersiz, Alt Eşiksiz Sistem

Without Top Handrail, Without Bottom Threshold System



Kayıslı Askı Tipi / Belt Strap



Zincirli Askı Tipi / Chained Strap

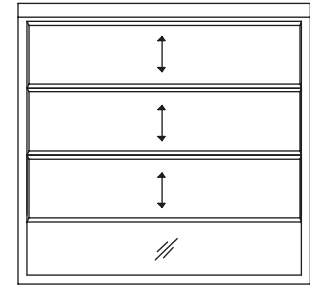
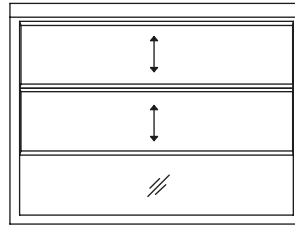
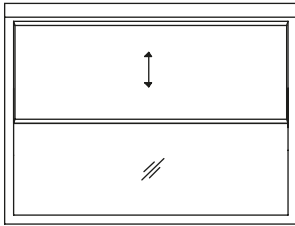

Kayar Panjur Sistemi Sliding Shutter System



SS60



Cepheye paralel bir şekilde ve kayarak hareket eden SS60 Kayar Panjur Sistemi, rulmanlar sayesinde kanatlar üstten taşınarak hareket eder. Tercihe göre sabit kullanılabilir. Üst ve alt ray sayıları artırılarak birden fazla kanadın üst üste paralel olarak çalışmasını sağlayan sistemdir.

The SS60 Sliding Shutter System, which moves sliding parallelly to the facade, moves from the top by being carried by rollers. It can also be used fixed. It is a system that allows to run more than one sash parallelly to each other by increasing the number of upper and lower rails.

SS60 Kayar Panjur Sistemi

SS60 Sliding Shutter System

TEKNİK ÖZELLİKLER / TECHNICAL PROPERTIES

Kasa Geniřliđi / Frame Width	60 mm
Lamel Profil Geniřliđi / Lamella Profile Width	60 mm
Profil Et Kalınlıđı / Profile Wall Thickness	1,4 - 2,5 mm
Maks. Kanat Geniřliđi / Max. Sash Width	1200 mm
Maks. Kanat Yksekliđi / Max. Sash Height	5000 mm
Maks. Kanat Ađırlıđı / Max. Sash Weight	70 kg

UYGULAMA SEENEKLERİ / APPLICATION OPTIONS

Paralel Hareket / Parallel Movement



Katlanır Hareket / Folding Movement

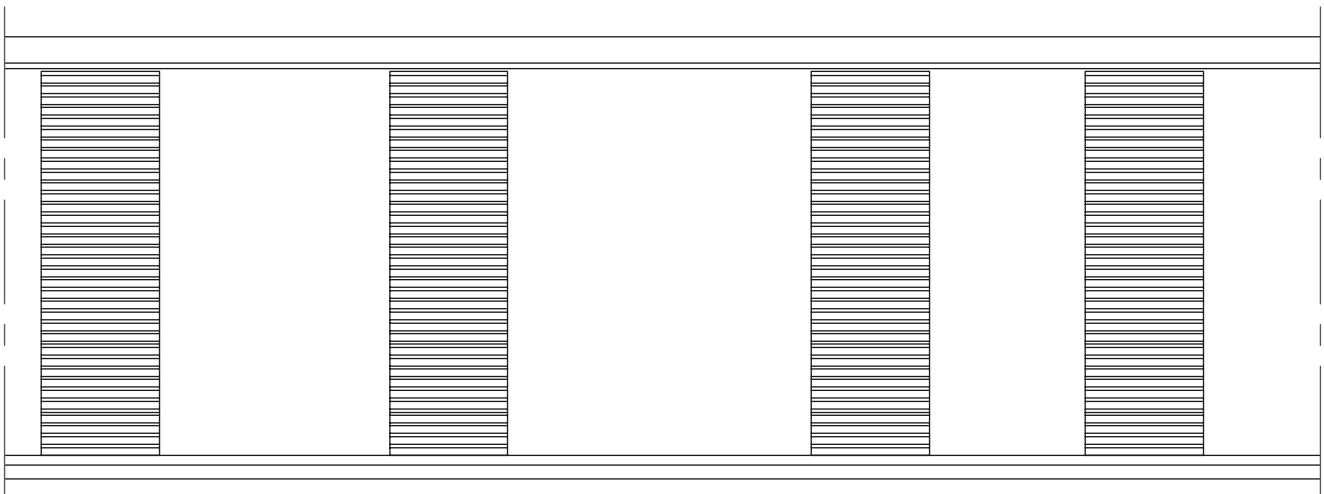

Katlanır Cam Balkon Sistemi
Folding Balcony Glazing System



CB40

Tek Camlı Katlanır Cam Balkon Sistemi

*Folding Balcony
Glazing System*

ICB40

Isıcamlı Katlanır Cam Balkon Sistemi

*Heat Insulated Folding
Balcony Glazing System*

**Açılı balkonlara özel çözümler
sunmayı başaran sistem.**

*The system that offers special
solutions for angled balconies.*



CB40 Tek Camlı Katlanır Cam Balkon Sistemi

CB40 Folding Balcony Glazing System

ICB40 Isıcamlı Katlanır Cam Balkon Sistemi

ICB40 Heat Insulated Folding Balcony Glazing System

TEKNİK ÖZELLİKLER / TECHNICAL PROPERTIES	ICB40	CB40
Kasa Geniřliđi / Frame Width	40 mm	40 mm
Kanat Geniřliđi / Sash Width	35 mm	40 mm
Profil Et Kalınlıđı / Profile Wall Thickness	1,3 - 2 mm	1,3 - 2 mm
Cam Kalınlıđı / Glazing Thickness	30 mm	8 - 10 mm
Maks. Kanat Geniřliđi / Max. Sash Width	600 mm	600 mm
Maks. Kanat Yüklseklıđi / Max. Sash Height	2900 mm	2900 mm
Maks. Kanat Ađırlıđı / Max. Sash Weight	60 kg	45 kg
Maks. Kanat Sayısı / Max. Sash Number	10 sol , 10 sađ	10 sol , 10 sađ

UYGULAMA SEÇENEKLERİ / APPLICATION OPTIONS

Düz Balkon / Flat Balcony



L tipi Balkon / L Type Balcony



U tipi Balkon / U Type Balcony



Oval Balkon / Oval Balcony

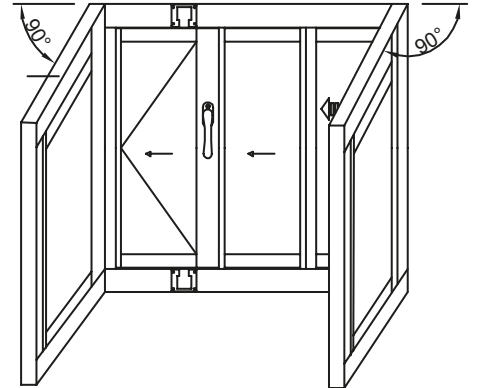
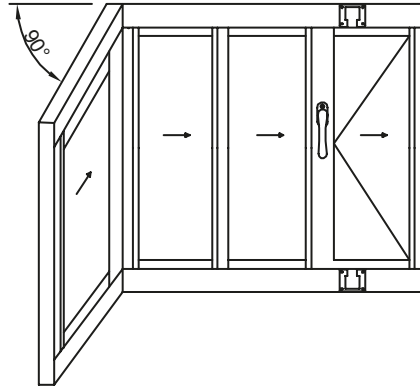
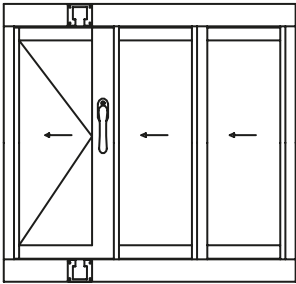

Sürme Cam Balkon Sistemi
Sliding Balcony Glazing System



SCB100 ISCB140

Sürme Cam Balkon Sistemi

Sliding Balcony Glazing System



Isıcamlı Sürme Cam Balkon Sistemi

Heat Insulated Sliding Balcony Glazing System



SCB100 Sürme Cam Balkon Sistemi

SCB100 Sliding Balcony Glazing System

ISCB140 Isıcamlı Sürme Cam Balkon Sistemi

ISCB140 Heat Insulated Sliding Balcony Glazing System

TEKNİK ÖZELLİKLER / TECHNICAL PROPERTIES

	SCB100	ISCB140
Kasa Geniřliđi / Frame Width	58-101 mm	140 mm
Kanat Geniřliđi / Sash Width	17,5 mm	24 mm
Profil Et Kalınlıđı / Profile Wall Thickness	1,4 - 1,7 mm	1,2 - 1,5 mm
Cam Kalınlıđı / Glazing Thickness	8 - 10 mm	20 mm
Maks. Kanat Geniřliđi / Max. Sash Width	1000 mm	1000 mm
Maks. Kanat Yüksekliđi / Max. Sash Height	3000 mm	3000 mm
Maks. Kanat Ađırlıđı / Max. Sash Weight	70 kg	90 kg
Maks. Kanat Sayısı / Max. Sash Number	5 sol , 5 sađ	4 sol , 4 sađ

UYGULAMA SEÇENEKLERİ / APPLICATION OPTIONS

3 Raylı Eşikli-Eşiksiz / 3 Railed With Threshold - Without Threshold



5 Raylı Eşikli-Eşiksiz / 5 Railed With Threshold - Without Threshold



U tipi Balkon / U Type Balcony



L tipi Balkon / L Type Balcony



4 Raylı Eşikli / 4 Railed With Threshold



4+4 Kanat Birleşimi / 4+4 Sash Combination

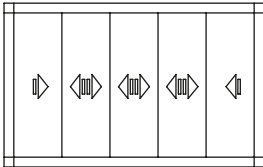

SCB100

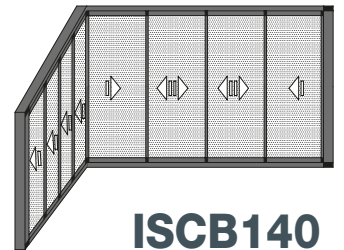
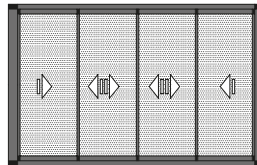
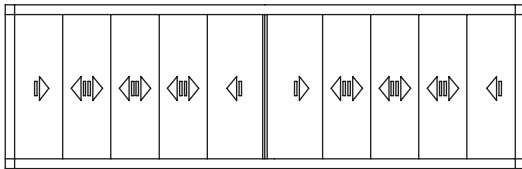
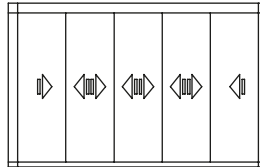

ISCB140

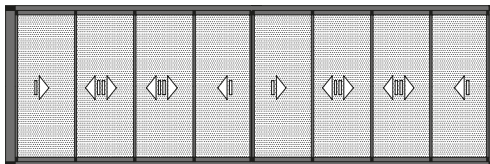



F60

- Farklı görünümde lambri çeşitleri,
 - Farklı lamel ebatları ile bütün veya boşluklu görünüm,ler,
 - Aksesuar çözümleri ile tek,çift kanat kapı ve sürme garaj kapıları yapabilme,
 - Bahçe depo ve açıkta kalan alanları kapalı ve dışarıdan görünmeyen alanlara çevirir.
- Different types of paneling that allows an aesthetic appearance,*
• Whole or hollow views with different coverslip sizes,
• Ability to make single, double sash doors and sliding garage doors with accessory solutions,
• Turns the garden, warehouse and open areas into closed and invisible areas from the outside

TEKNİK ÖZELLİKLER / TECHNICAL PROPERTIES

Dikme Genişliği / Pole Width	60 mm
Panel Genişliği / Panel Width	60 - 150 mm
Profil Et Kalınlığı / Profile Wall Thickness	1,2 - 1,5 mm
Panel Derinliği / Panel Depth	14 mm
Min. Dikme Aralığı / Min. Pole Space	400 mm
Maks. Dikme Aralığı / Max. Pole Space	1600 mm
Maks. Çit Yüksekliği / Max. Fence Height	1800 mm

UYGULAMA SEÇENEKLERİ / APPLICATION OPTIONS

- L tipi Bölme / L Type Partition**
- Açılı Bölme / Angled Partition**
- T tipi Bölme / T Type Partition**
- 4'lü Bölme / Quart Partition**

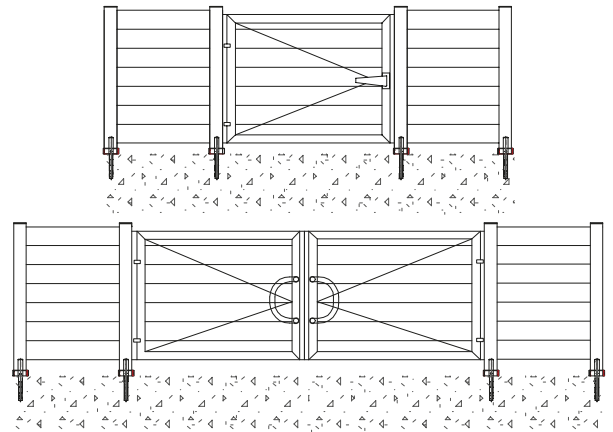
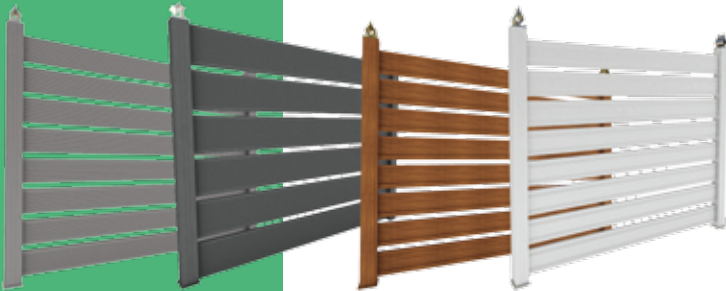

KALİTE VE GÜVENİN SİMGESİ...
THE SYMBOL OF QUALITY AND TRUST...



www.celsametal.com.tr